

EN Installation and User Manual
Mito Sensor
item 113205650 / 113215650



CONTENTS

GENERAL DESCRIPTION	3
Supplied parts	3
INSTALLATION	4
Introduction	4
Safety regulations	4
Installation	5
Lock characteristics	7
Final testing	8
Regulatory compliance	8
Power supply cable characteristics (supplied)	9
Power supply characteristics	10
Warning	10
OPERATION	11
Maintenance	11
Certificate of compliance with the Construction Products Regulation No. 305/2011	11
How to correctly dispose of packaging materials	11
FAQ	12
ACCESSORIES AVAILABLE UPON REQUEST	14

GENERAL DESCRIPTION

All the models in the Mito Sensor lock range are designed to mechanically enable and disable the door handle. When the "false throw" function is enabled, the handle is 'idle' if there is no power input and the latchbolt cannot be withdrawn. With power input, the handle is enabled to open the door; when it is turned, the latchbolt withdraws.

Every lock in this range is:

- non-handed, so it can be installed on both right-hand and left-hand doors;
- equipped with the mechanical hold open function, which is activated by disabling the "false throw" with the cylinder;
- pre-set to install a light (LED) where: GREEN indicates HANDLE ENABLED TO OPEN, RED indicates HANDLE NOT ENABLED TO OPEN, as shown below:

FALSE THROW NOT ENABLED	FALSE THROW ENABLED AND	
	ELECTRICAL IMPULSE	NO ELECTRICAL IMPULSE
GREEN LED	GREEN LED	RED LED

This product can be installed on hinged doors that do not exceed 400 kg in weight, 2500 mm in height and 1300 mm in width.

 **N.B.: The lock is not motorised, therefore even when it is electrically powered, the handle must be turned manually to withdraw the latchbolt.**

SUPPLIED PARTS:

Part no.	Description	Pieces
1	Mito Sensor Lock	1
2	1.5 m power supply cable	1

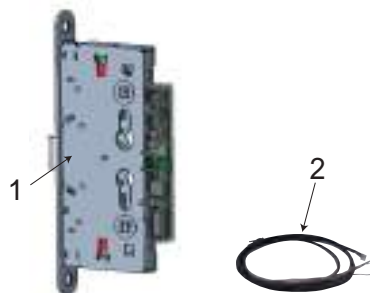

INSTALLATION

INTRODUCTION

This manual is an integral part of the product and has been compiled by the manufacturer to provide everyone authorised to interact with it with the information they may need. Keep this manual in an easily accessible place for the working life of the product.

SAFETY REGULATIONS

Read the instructions in the installation and user manual carefully.

All installation and maintenance operations which require precise technical expertise or particular skills must be carried out exclusively by qualified personnel with the relevant qualifications and experience.



The Mito Sensor lock is powered by a 12/24V AC/DC power supply. For more information, please refer to the section "Power supply characteristics".



Do NOT weld the lock or any part of it.



If there is a momentary power failure:

- the door can always be opened with the key.***
- the door can be opened with the handle, independently of whether the "false throw" is enabled or disabled. Once power is restored, the lock will remain idle until it receives a new electrical impulse.***

INSTALLATION

! Do not open the Mito Sensor lock or modify it in any way, otherwise the warranty will be void.

! Before installing the lock in the recess in the door, carry out the following operations:

- Select the hand using the dedicated lever (as shown in figure 1).
 - For left hand installation, move the lever completely towards the letter “L” and release it.
 - For right hand installation, move the lever completely towards the letter “R” and release it.

N.B.: once it is released, the lever will always return to the 'rest' position, as shown in the figure below:

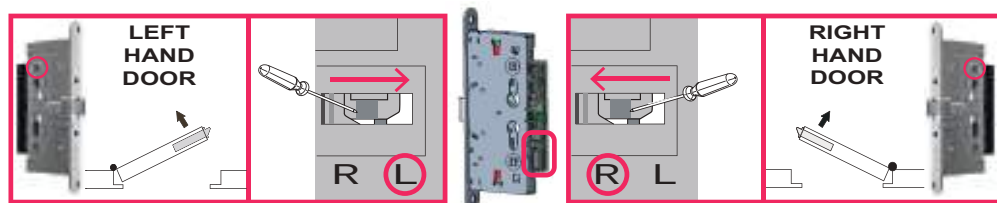

Figure 1: lever for changing “hand”

- Selecting the opening time:
 - insert a 2 mm flathead screwdriver in the hole shown in figure 2;
 - turning clockwise to the end stop (notch II) will set the opening time to 30 s;
 - Turning anticlockwise to the end stop (notch I) will set the opening time to 3 s

N.B.: the Mito Sensor lock is factory set for an opening time of approx. 10 s.

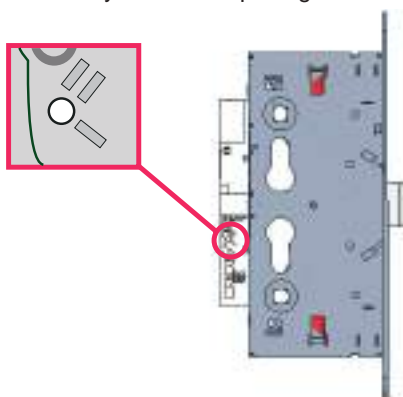

Figure 2: timer hole

- If the lock is installed with the optional LED (item 107126100), please see figure 3 for how to fit the connector correctly;



Figura 3: fitting the connector

- Place the lock in the recess created in the door, taking care not to force it. Fix the lock using screws (minimum 5 mm).
- Use a 9 mm square spindle, taking care not to force it when inserting it.
- In the standard versions, make sure that once the spindle is inserted, it goes beyond the lock follower.
- The MITO SENSOR lock must always be installed together with a cylinder, fitted using the dedicated fixing screw.
- Use only cylinders with a DIN cam.
- Use a zinc-plated fixing screw for the cylinder: M5 - ISO 7046-1; Length 70 mm or 75 mm
- Check that the striker used does not protrude, preventing the door and lock from working properly.
- Check there is no friction between the lock latchbolt and the striker. If there is, make the striker hole larger.
- If there is friction when the lock is fitted in the door, do not force it.
- The lock may be installed and operated only after checks have been carried out to ensure the door has been correctly installed.
- Once installation is complete, lubricate the latchbolt surfaces touching the striker.



- ***Do not force the handle in the opposite direction to the normal opening one.***
- ***Make sure no foreign bodies, debris from working on the door, packaging/power supply cable ties or anything else that could interfere with the inner mechanisms are inserted or get into the lock.***
- ***Make sure the sloping part of the latchbolt touches the striker or the recess on the frame.***
- ***The distance between the lock faceplate and the door frame and/or the striker where the latchbolt engages) must be that indicated by the door manufacturer (minimum 3 mm).***
- ***If the lock or other parts of the door are replaced, always follow the instructions of the door manufacturer.***
- ***Do not use the lock without first having installed a cylinder, fitted using the dedicated fixing screw.***

LOCK CHARACTERISTICS

Power supply voltage 12/24 VDC/VAC

Absorbed current (max)750mA @12VAC (see the table below for all other cases)

Degree of protection IP X0

Operating temperature/humidity-10°C / +55°C (95% RH)

Certifications See "Safety and Regulatory Addendum"

POWER SUPPLY VOLTAGE	MAX ABSORBED CURRENT
24 VAC	350 mA
24 VDC	250 mA
12 VAC	750 mA
12 VDC	450 mA

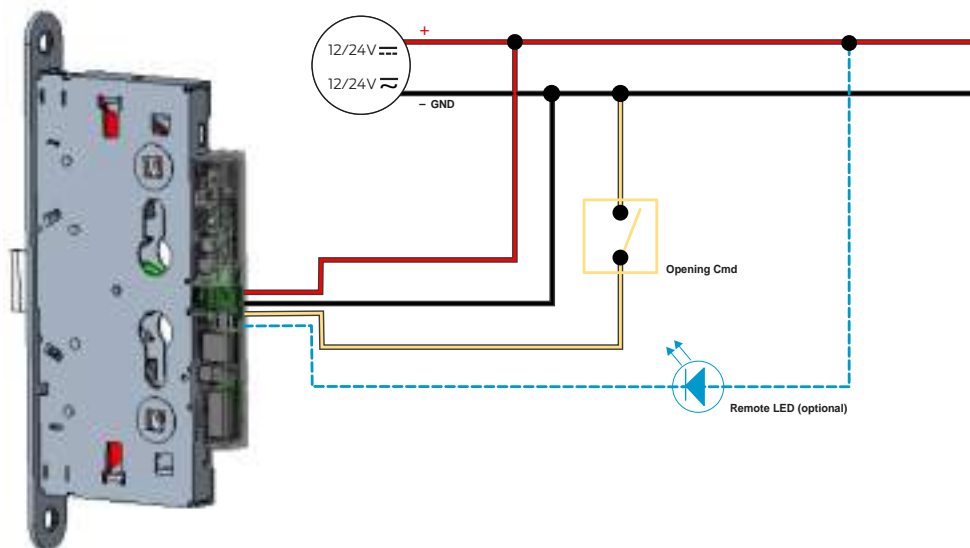

FINAL TESTING

CARRY OUT FINAL TESTING ONLY WHEN THE LOCK HAS BEEN CORRECTLY FITTED ON THE DOOR AND WITH THE CYLINDER INSTALLED AND FIXED USING THE DEDICATED SCREW.

- Enable the "false throw" function by turning the cylinder key in the locking direction:
 - check that the LED (if fitted) changes from GREEN to RED.
 - press down the handle: the latchbolt MUST NOT withdraw;
- Give the electrical impulse to open:
 - check that the LED changes from RED to GREEN.
 - turn the handle and check that the latchbolt withdraws;
 - wait for the end of the electrical impulse (the time will vary depending on the lock timer setting);
 - check that the LED (if fitted) changes from GREEN to RED;
 - press down the handle, the latchbolt MUST NOT withdraw;
- Disable the "false throw" function by turning the cylinder key in the opening direction:
 - check that the LED (if fitted) changes from GREEN to RED.
 - continue turning the key and check that the latchbolt withdraws, allowing the door to open;
 - again with the "false throw" function NOT enabled, turn the handle and check that the latchbolt withdraws, allowing the door to open;

REGULATORY COMPLIANCE

The product is compliant with the Construction Products Regulation 305/2011. It is also compliant with the electromagnetic compatibility directive.

Please refer to the 'Safety and Regulatory Addendum' (included in the pack) for the complete list of directives/regulations with which the product is compliant.

POWER SUPPLY CABLE CHARACTERISTICS (SUPPLIED)

Pinout	Colour of wire	Signal	Descriptions
1	Red	V+	Positive voltage
2	Black	V-	Negative voltage
3	Yellow	OCMD	Opening command
4	Blue	Remote LED	Remote LED

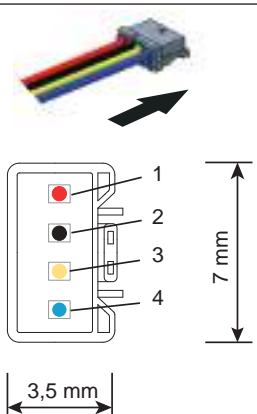

Use the cable supplied with the lock only.



For instructions on running the power supply cable between the door and the frame, see the accessory section.



The cable supplied can be connected with the existing electric system. CISA is not responsible for the electrical connections with the rest of the system.

POWER SUPPLY CHARACTERISTICS



A power supply with the following characteristics is recommended:

- *CE marked,*
- *compliant with directives 2014/30/EU, 2014/35/EU Class 2 (double insulation)*
- *LPS source (in compliance with IEC 62368)*
- *OVP (overvoltage) and OCP (overcurrent) SELV protection*
- *UL94-V0 type plastics*
- *UL Listed or at least UL Recognized product*
- *in the case of AC power, use the GEWISS GW 96426 power supply*



Do not connect the lock directly to the 230V AC mains.

WARNING

- Read these instructions carefully and save them for future use.
- All the data and declarations contained in this sheet replace and supersede those contained in other sheets.
- Always disconnect the electric system from the mains when connecting the cables or performing any later work on the lock.



CISA declines all responsibility for damage resulting from the failure to observe the above warnings

OPERATION

MAINTENANCE

Regular maintenance of the lock is recommended. The following actions should be taken:

- Withdraw the latchbolt using the handle and cylinder and check there is no friction.
- Enable and disable the "false throw" function and check there is no friction.
- Make sure that all the fixing screws and the cylinder fixing screw are properly screwed in and that the door shuts properly when closed.
- Check that once the latchbolt has entered the striker there is no friction.
- Check the contact surfaces of the latchbolt and striker are well lubricated. If necessary, lubricate with a suitable product.
- Do not paint any visible parts of the lock (faceplate, latchbolt, etc.).
- If the lock does not work properly or if there is evidence it has been forced, it must be replaced.

CERTIFICATE OF COMPLIANCE IN ACCORDANCE WITH CONSTRUCTION PRODUCTS REGULATION NO. 305/2011

- "MITO SENSOR" series mortice lock
- Classified in accordance with EN 14846:2008 - 3 S 9 D 0 J 0 0* 3 (* if the lock is used with the LED (item 107126100) or one with equivalent characteristics, the eighth digit becomes a 1)
TRUE copy of document **0425-CPR-3573** can be downloaded from website: www.cisa.com (locks, fire door locks, MITO Panic)
- Suitable for application on FIRE doors
- The full copy of the Declaration of Performance can be found and downloaded from www.cisa.com (locks, fire door locks, MITO Panic).

HOW TO CORRECTLY DISPOSE OF PACKAGING MATERIALS

With reference to recent provisions on waste management and the disposal of packaging waste, please follow the instructions contained in the link below:

<https://www.cisa.com/content/dam/cisa/documenti/CISA-packaging-recycling.pdf>

FAQ

FAQ	Action	Checks and controls	Possible solution
#1	<p>Operation The lock does not open with the electrical impulse and the LED does not go on.</p> <p>Possible cause: Power supply error</p>	<p>Measure the lock input voltage</p>	<ol style="list-style-type: none"> 1) The nominal input voltage must be 12/24 VDC/VAC. Use a suitable power supply if the voltage detected is incorrect. 2) Connect the supplied power supply cable correctly. 3) If the input voltage exceeds 27 VAC, the lock might be damaged.
#2	<p>Operation The lock does not open with the electrical impulse but the LED goes on correctly.</p> <p>Possible cause 1: The lock is fitted with the incorrect hand.</p> <p>Possible cause 2: The power supply cable wires are not connected properly.</p>	<p>Action 1: Check the hand of the lock (see "INSTALLATION" Page 5).</p> <p>Action 2: Check that the red, black and yellow wires are connected correctly (see "LOCK CHARACTERISTICS" Page 7)</p>	<ol style="list-style-type: none"> 1) Remove the lock from the door and set it to the correct hand using the selector provided. 2) Connect the wires according to the schematics in the installation manual
#3	<p>Light signal The lock opens with the electrical impulse but the LED does not go on.</p> <p>Possible cause: Incorrect installation</p>	<p>Check that the LED is connected correctly to the wire coming from the lock.</p>	<p>Remove the lock from the door and connect the LED correctly (see "INSTALLATION"- Figure 3: fitting the connector Page 6)</p>
#4	<p>Operation The amount of time the lock stays open is too long/short.</p> <p>Possible cause: Incorrect trimmer adjustment.</p>	<p>Change the trimmer setting.</p>	<p>Remove the lock from the door and adjust the trimmer using a small screwdriver. (see "INSTALLATION" Page 5).</p>
#5	<p>Light signal The LED signals are the opposite to those indicated on the instruction sheet.</p> <p>Possible cause: The LED connector has been inserted incorrectly (reversed)</p>	<p>Check the LED cable connector.</p>	<p>Disconnect the LED and insert the connector correctly. (see "INSTALLATION" - Figure 3: fitting the connector Page 6)</p>

FAQ	Action	Checks and controls	Possible solution
#6	<p>Operation The handle does not return to rest position.</p> <p>Possible cause: The screws fixing the handles or handle to the panic exit device are too tight.</p>	Check the torque of the fixing screws.	Slightly loosen the torque of the handle fixing screws.
#7	<p>Operation The lock stays open even at the end of the electrical impulse.</p> <p>Possible cause: Lock remains in mechanical hold open mode.</p>	Check lock status	Disable the "false throw" using the key and check the electrical impulse is working properly.

ACCESSORIES AVAILABLE ON REQUEST

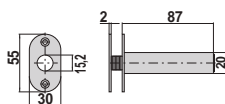

Concealed cable guard

1 06515 00 0

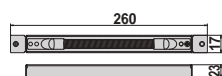

Internal cable guard with spring

1 06515 15 0

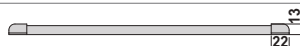

External cable guard with spring (L=300 mm).

1 06515 20 0



External cable guard with spring (L=600 mm).

1 06515 21 0

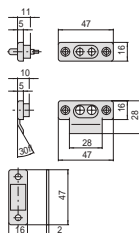

Pair of nylon contacts complete with 2 mm spacers (4 4).

1 06510 00 0

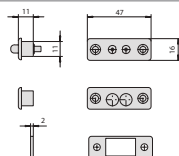

Pair of nylon electrical contacts

1 06510 10 0



Two-way green/red LED

1 07126 10 0

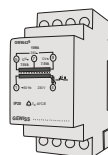

Power supply:

1 07302 08 0

About Allegion

Allegion (NYSE: ALLE) is a global pioneer in seamless access, with leading brands like CISA®, Interflex®, LCN®, Schlage®, SimonsVoss® and Von Duprin®. Focusing on security around the door and adjacent areas, Allegion secures people and assets with a range of solutions for homes, businesses, schools and institutions.

For more, visit allegion.com.

AXA   BRICARD  Briton  CISA  interflex  KRYPTONITE  NORMBAU  SimonsVoss Technologies  TRELOCK



CISA SpA
Via Oberdan 42
48018 Faenza (RA) Italy



Customer Service and Technical Support
+39 0546 188 0070



Ph. +39 0546 677111
Fax +39 0546 677150



cisa.com
cisa.sales@allegion.com



ALLEGION